

Reflash Procedure

NOTE: When the system is updated, all factory defaults are restored and personal settings (such as display and sound adjustments) are lost, including favorites information and phones paired with the system. Before starting the reflash procedure, obtain the customer's acceptance for this loss.

1. Record the customer's radio favorites (AM/FM/XM).
2. Remove the SD card from the slot.
3. Turn the ignition switch to OFF.

NOTE: All electrical loads should be turned off during the reflashing process, especially the air conditioner (blower), rear defogger, and room lamps.

4. Install the ROOM FUSE and AUDIO FUSE to the fuse block in the engine compartment (if not installed).
5. Connect battery charger (charge current maintained about 7A) to the vehicle to stabilize voltage fluctuation.
6. Press the START/STOP ENGINE push button 1 time without depressing the clutch pedal (manual transaxle) or the brake pedal (automatic transaxle), to switch the ignition position to ACC. Confirm that the push button start indicator light (A) is illuminated (amber) and the display in the instrument cluster is OFF (ignition position is in ACC).

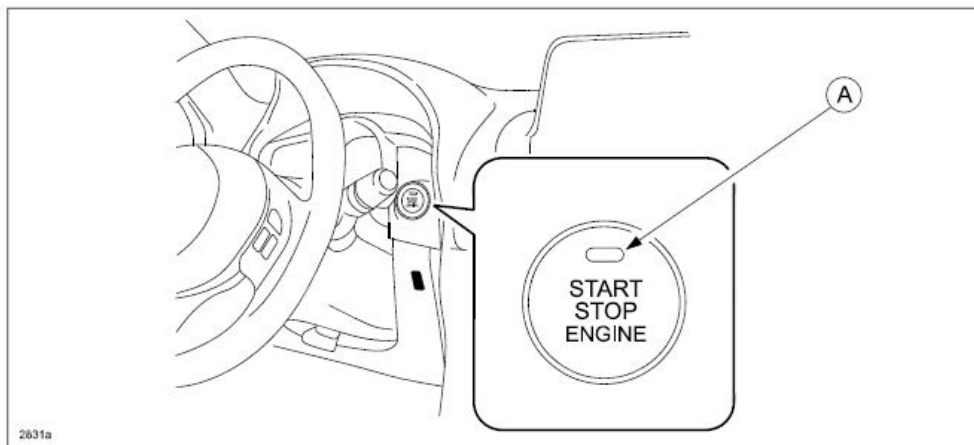

NOTE: The engine starts by pressing the push button start while depressing the clutch pedal (manual transaxle) or the brake pedal (automatic transaxle). To switch the ignition position without starting the engine, press the START/STOP ENGINE push button without depressing the pedal.

NOTE: If the ignition is left in the ACC position it will automatically switch off after 25 minutes. Pressing and releasing the clutch pedal (Manual Transaxle) or the brake pedal (Automatic Transaxle) before 25 minutes resets the timer to ensure the vehicle does not switch off during the reflash process.

7. Verify that there is a sound coming from the speakers. If sound cannot be heard, turn the volume dial (A) to turn the volume up, or make sure that MUTE is not on.

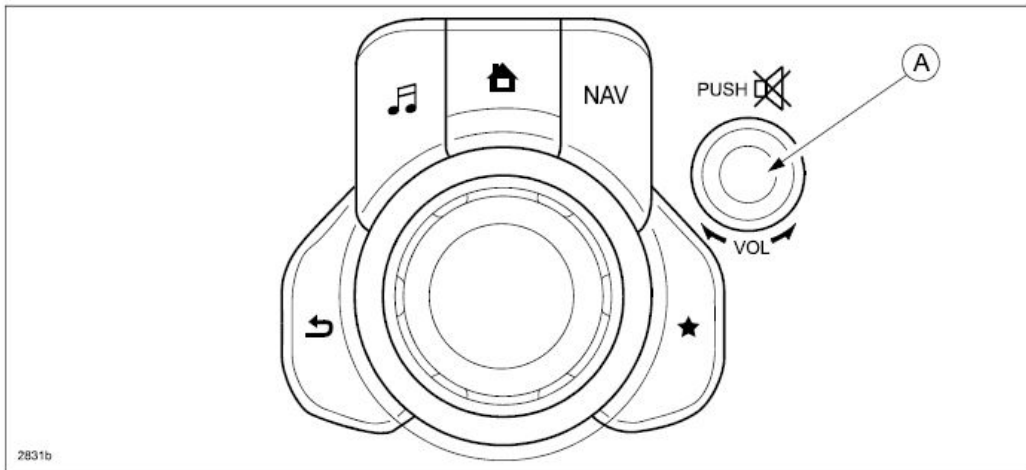

NOTE: When sound is heard from the speakers, the system is in stand-by condition.

8. Connect the prepared USB memory stick to the either one of the two USB port (A).

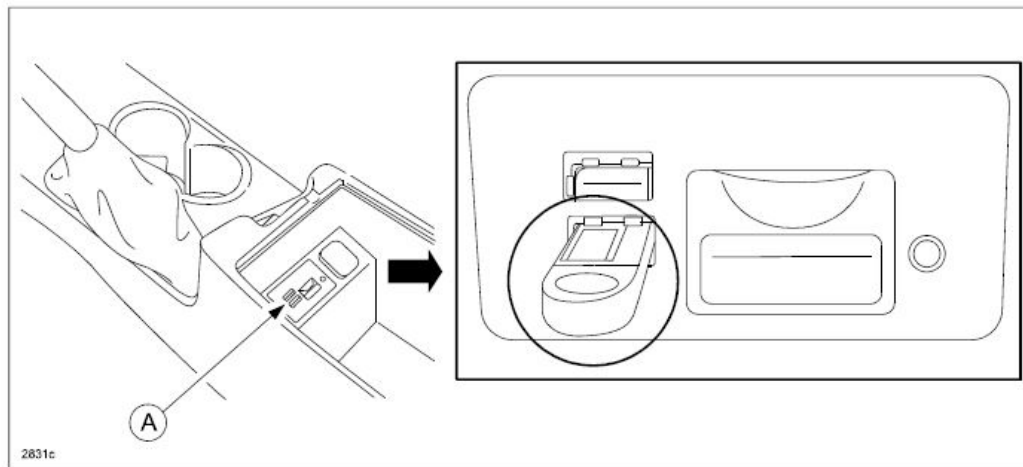

NOTE: There should only be the prepared USB memory stick inserted in one of the USB ports. Nothing should be inserted in the other USB port during the re-flashing process.

9. When the USB memory stick is recognized, the following message will appear briefly on the screen.

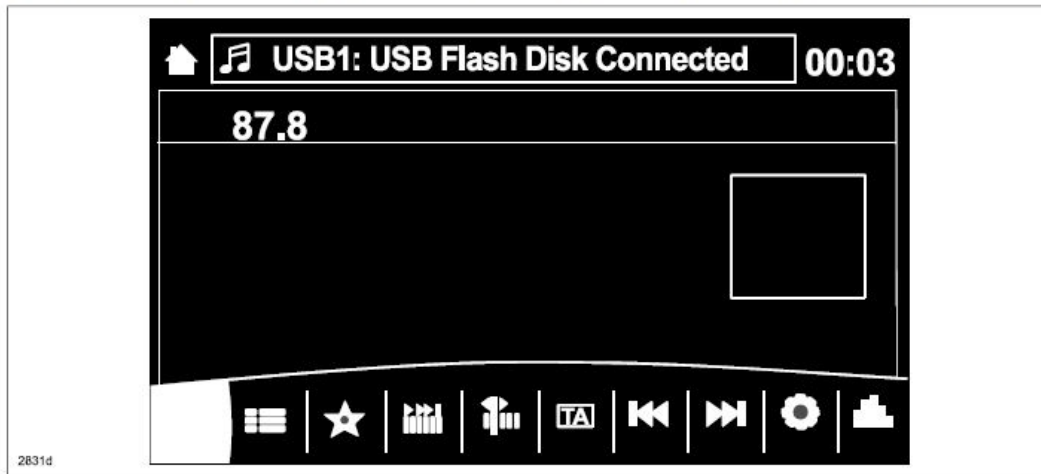

NOTE:

- It takes approx. 5 seconds before the USB memory stick is recognized.
- If the USB memory stick is not recognized, perform the following:
 - (1) Select "Setting".
 - (2) Select "System".
 - (3) Select "Factory Reset".
 - (4) Push the commander switch knob (A) to "Enter".

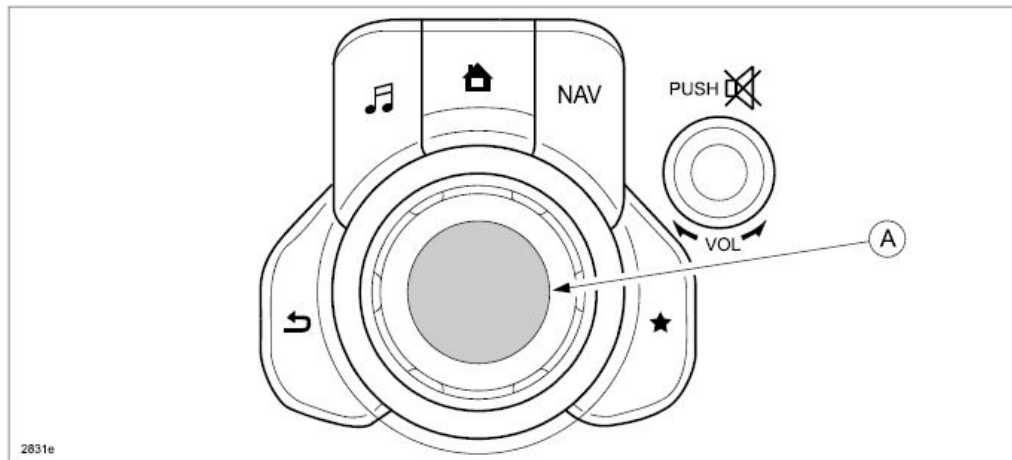

10. Press the three buttons (Music (A) + Favorites (B) + Volume Mute(C)) on the commander switch at the same time for 2-5 seconds and the Diagnostic Test Screen will appear.

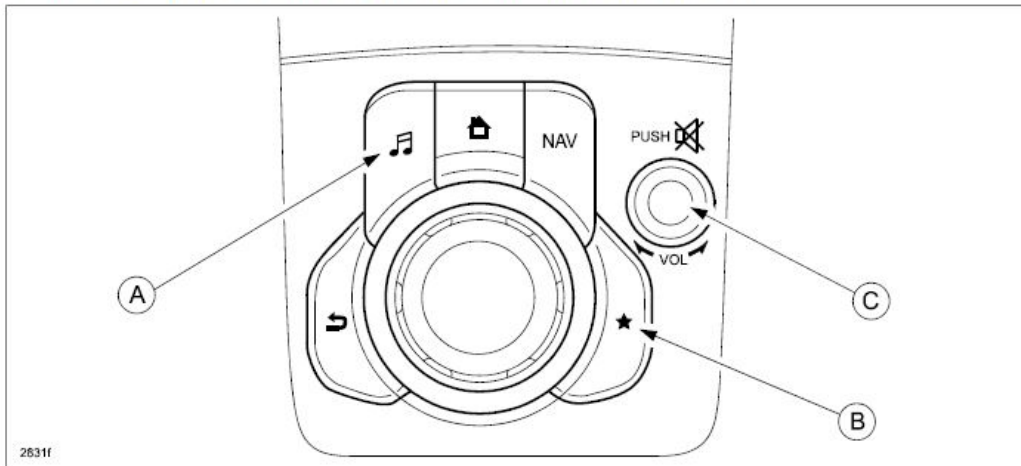

11. On the test screen, input '3' and then select "ENTER" to verify whether any DTCs (in the CMU) are active. Select "CLEAR" to go to next step.

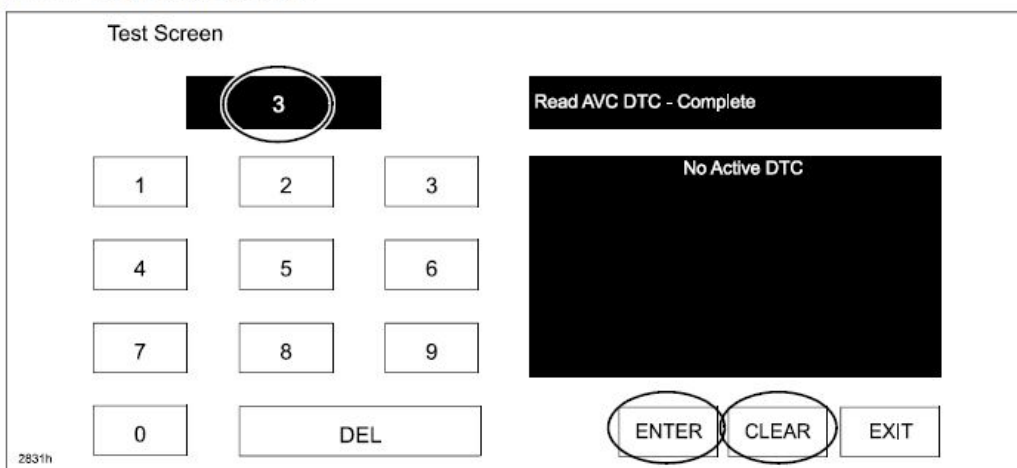

12. If any DTCs are present, input '2' on the test screen and then select "ENTER". This will internally clear all the earlier set DTCs (in the CMU). Select "CLEAR" to go to next step.

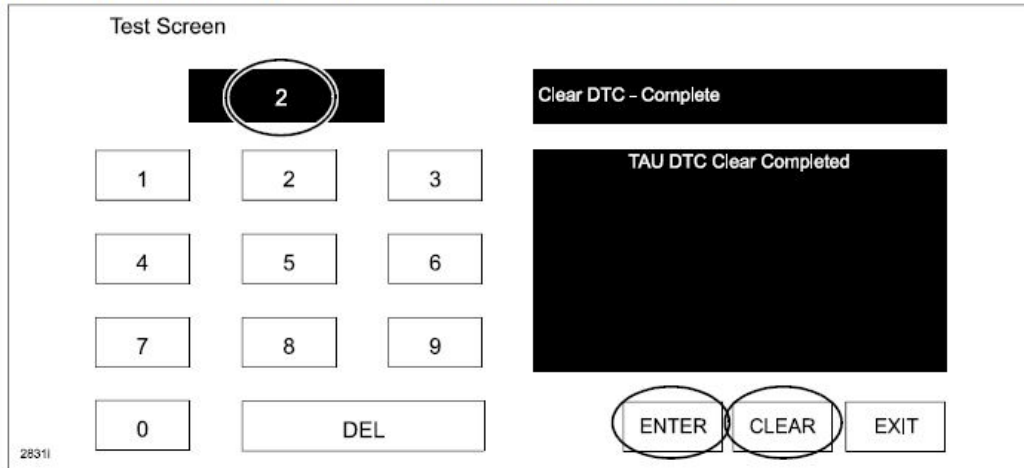

13. Use the touchscreen or the commander switch to input '99' and then select "ENTER" on the Test screen.

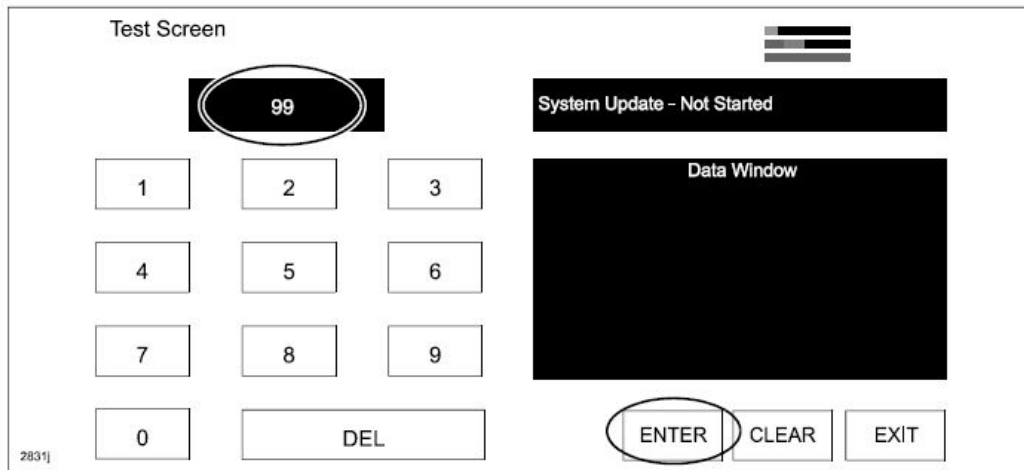

14. Select "Search" on the screen below.

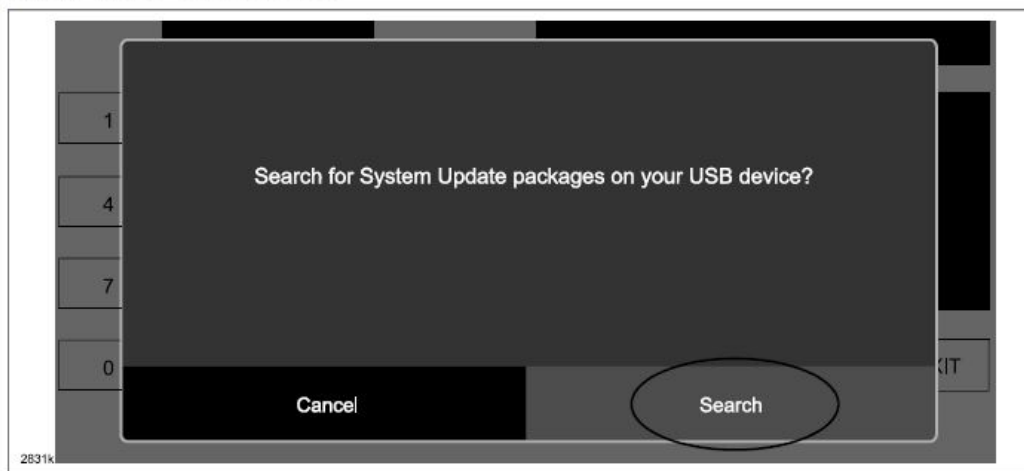

NOTE: If the following screen is displayed, perform the following.

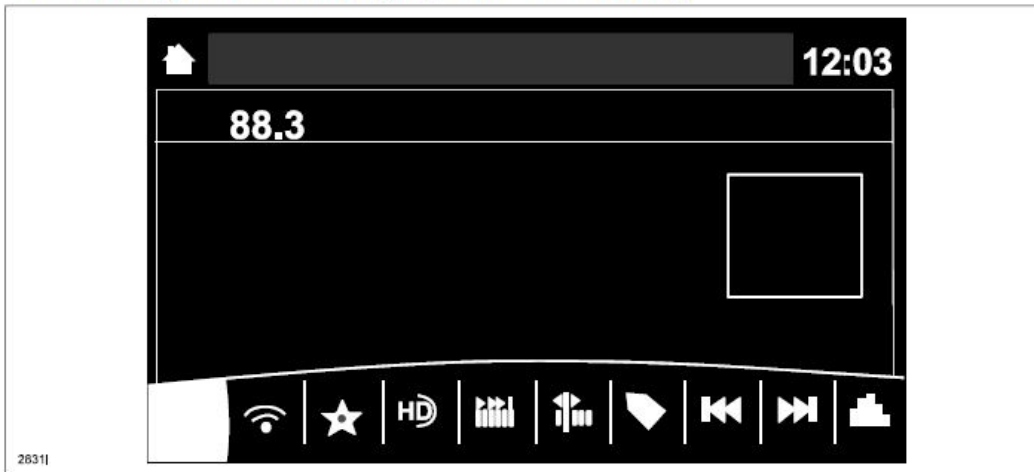

(1) Press the "Return" button (A) on the commander switch.

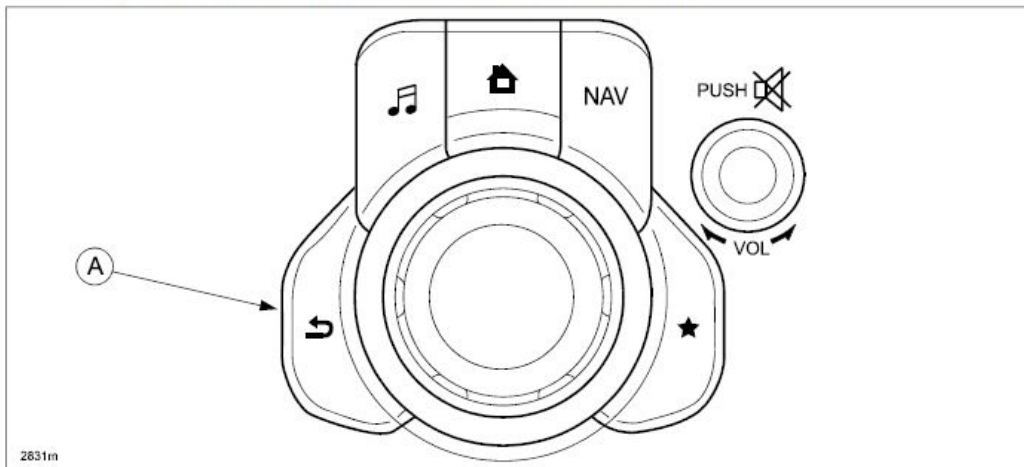

(2) Verify that the screen changes back to the screen below.

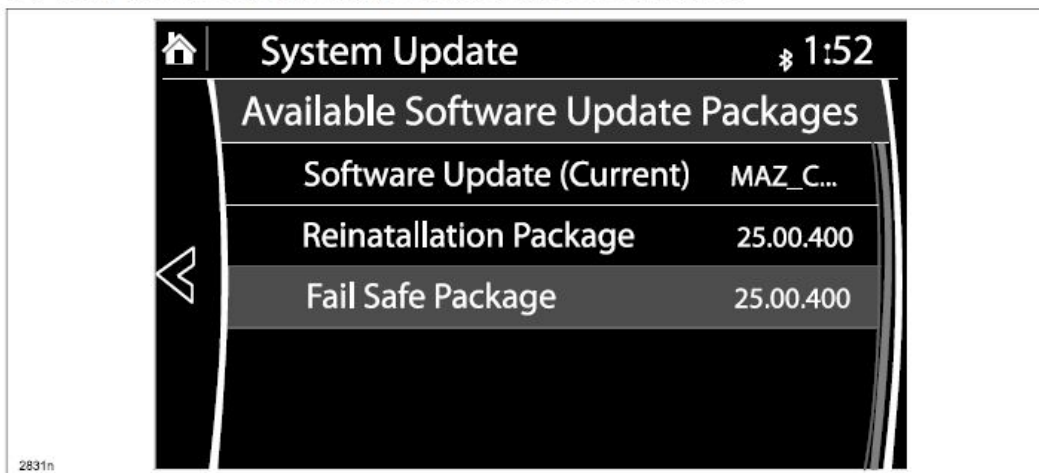

15. Select "Fail Safe Package" first using the touch screen.

CAUTION: Always do the "Fail Safe Package" first, followed by "Reinstallation Package".

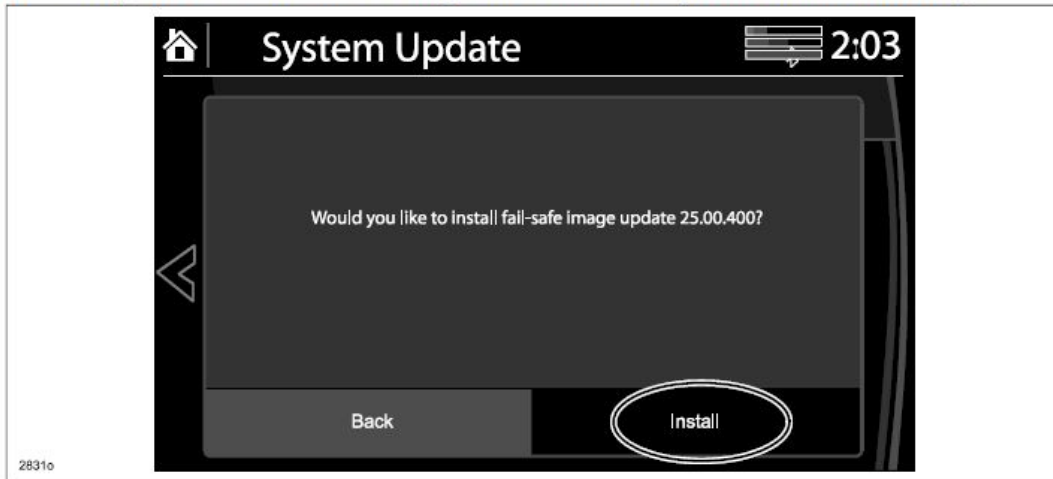

16. Select "Install" on the screen below and the Failsafe installation process will start.

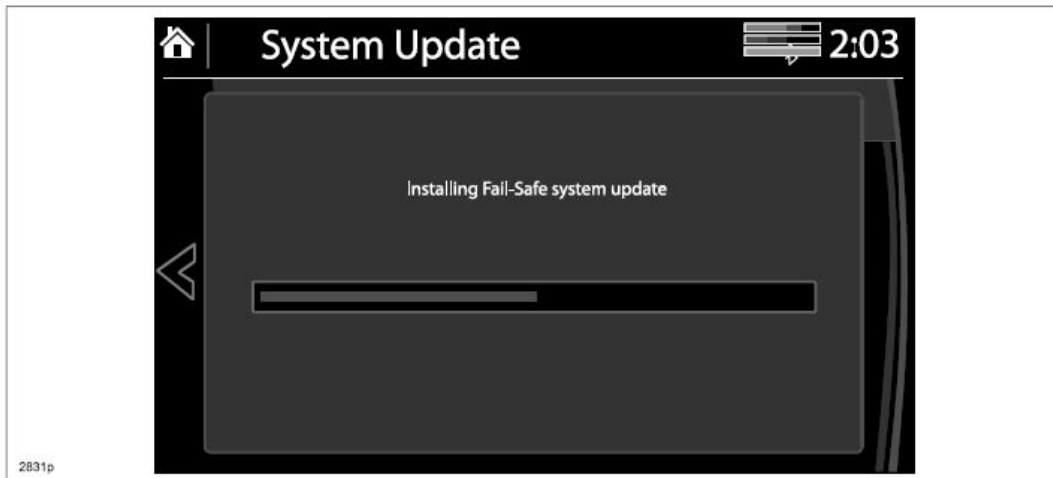

17. After the Failsafe installation process is completed, select "OK".



18. Press and release the clutch pedal (Manual Transaxle) or the brake pedal (Automatic Transaxle) and proceed with the following steps without stopping.

NOTE: If the ignition is left in the ACC position it will automatically switch off after 25 minutes. Performing this step resets the timer to ensure the vehicle does not switch off while installing the reinstallation package.

19. Press the three buttons (Music (A) + Favorites (B) + Volume Mute(C)) on the commander switch at the same time for 2-5 seconds to open the Diagnostics Test screen again.

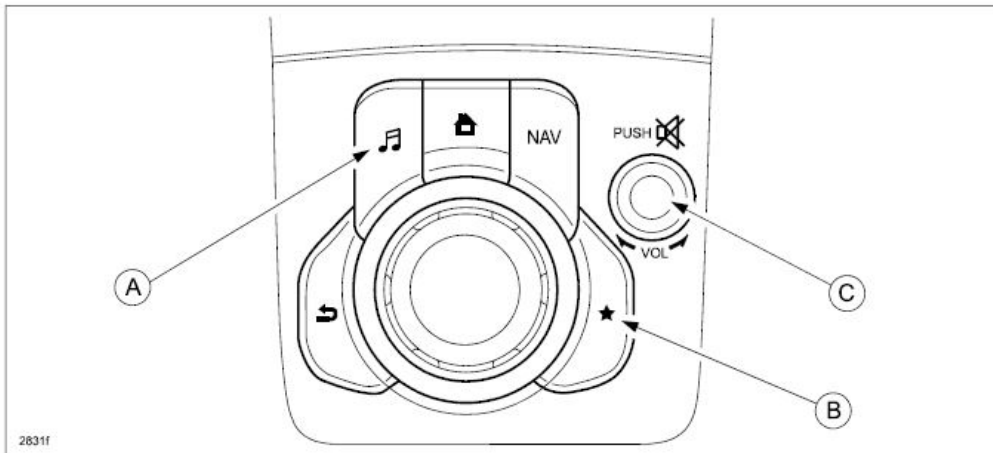

20. Use the touchscreen or the commander switch to input '99' and then select "ENTER" on the Test screen.

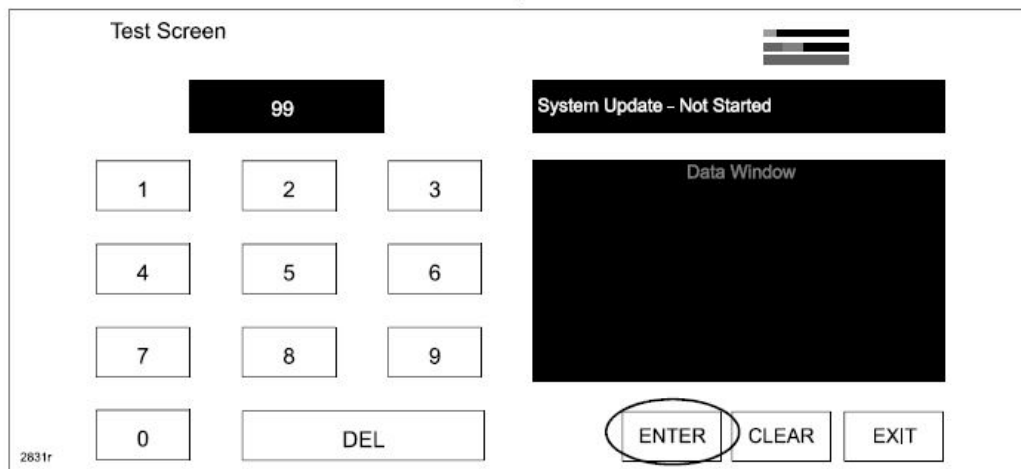

21. Select "Search" on the screen below.

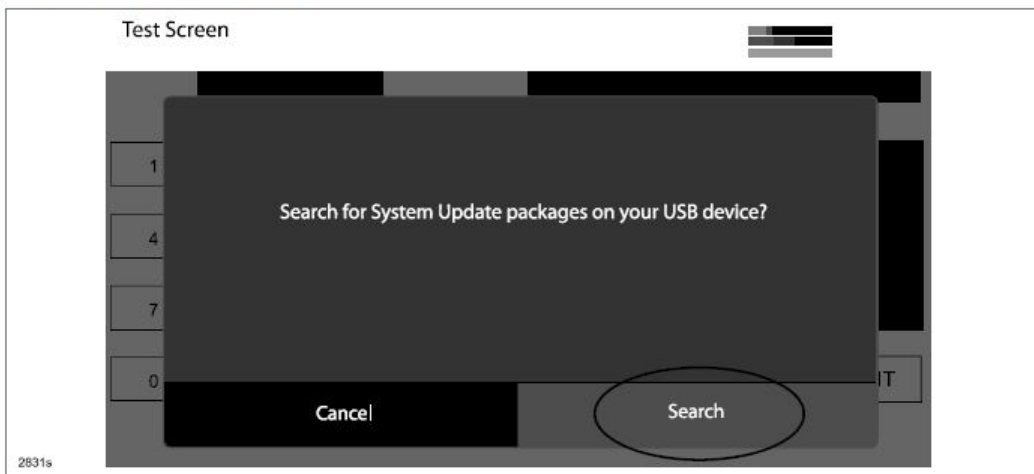

22. Select "Reinstallation Package" on the screen below.

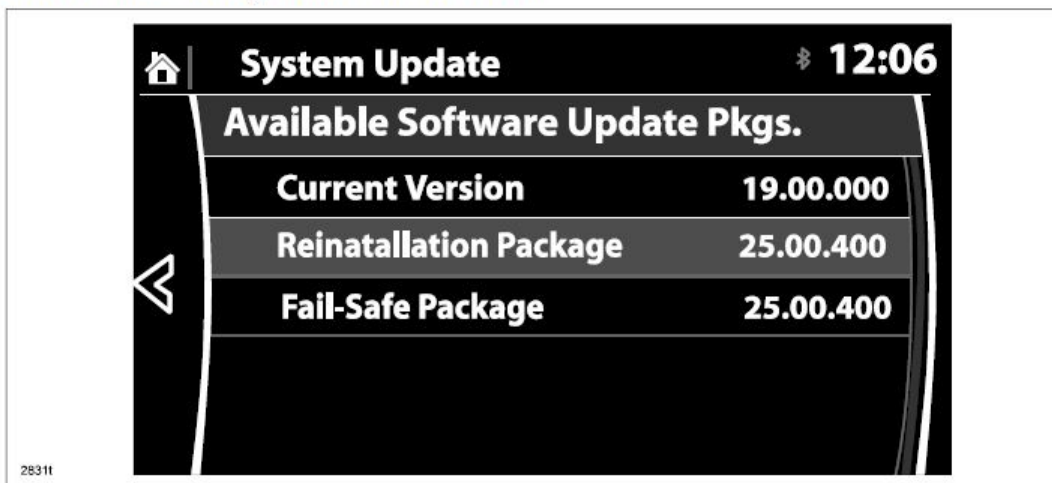

23. Select "Install" on the screen below.

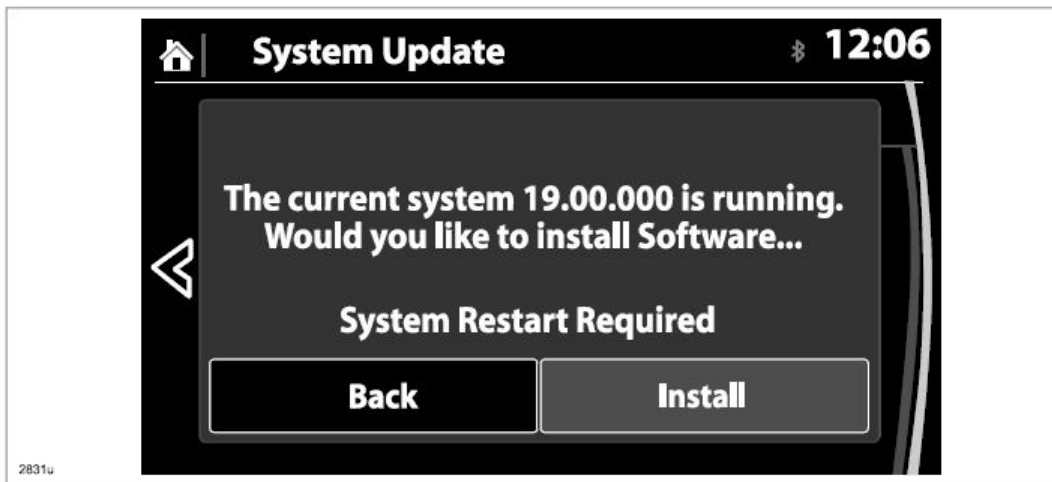

24. The screen below will be displayed.

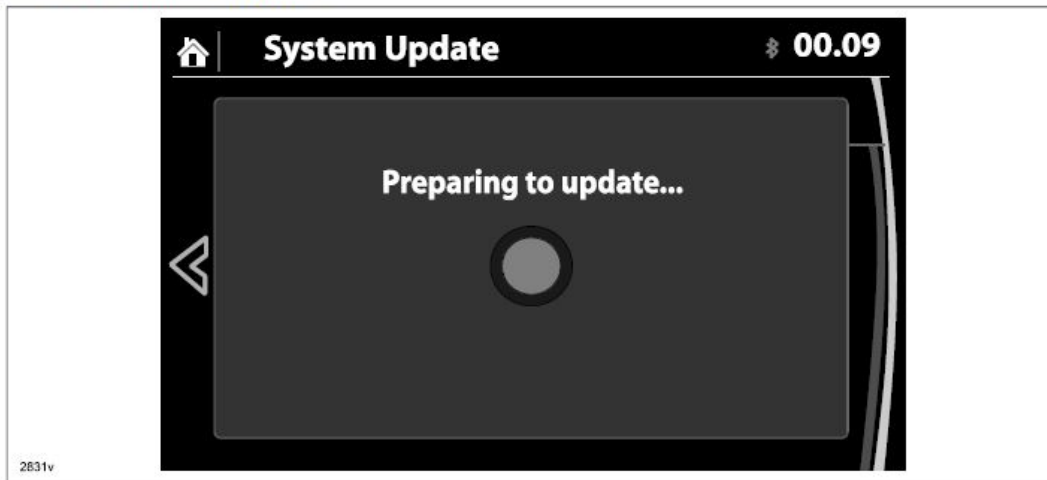

NOTE: A blank screen is displayed momentarily. It will take approx. 2 minutes before the reflashing process moves to the next screen.

25. Reinstallation will start from 0% and as the reflashing process takes place, the progress bar will gradually increase to 100%.

NOTE: In order to avoid the ACC power being turned off during the reflashing process, press and release the clutch pedal (Manual Transaxle) or the brake pedal (Automatic Transaxle) before 25 minutes if needed.

NOTE: It may be difficult to read the display at times as it becomes dark, but "Do not restart vehicle at this time" is displayed.



NOTE: It will take some time for the reflashing process to get from 98 % to “100%.”

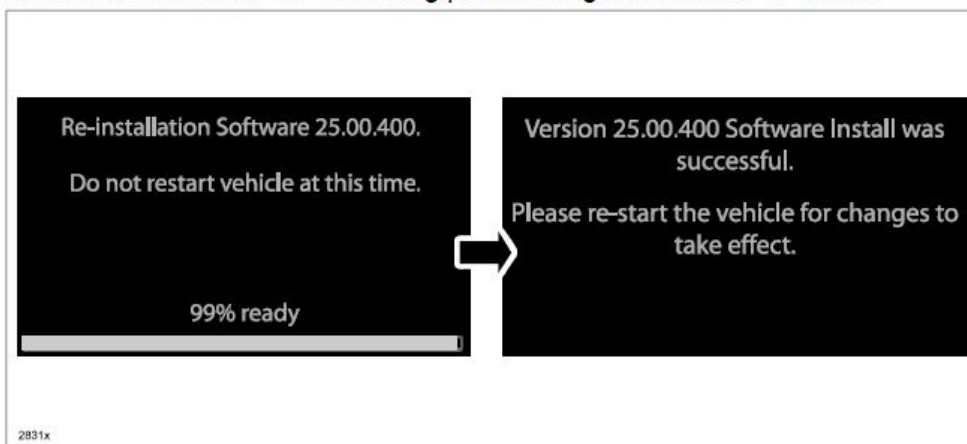

26. After the update is completed with the above right screen, confirm that the push button start indicator light is illuminated (amber) and the display in the instrument cluster is OFF (ignition is in “ACC”). If the ignition is “OFF” and the push button start indicator light is not illuminated (amber), turn the ignition to “ACC” and one of the following two screens will be displayed.

Type A: Reprogramming has already been completed. Go to next step.



Type B: The ignition was turned “OFF” during the reflashing process. This screen will continue to be displayed until reflashing is completed. After the reflashing is completed, go to next step.

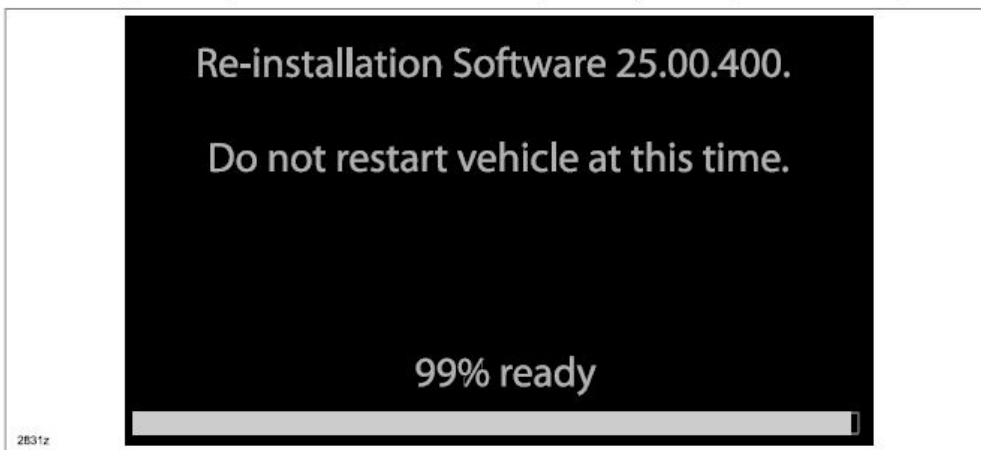

27. Turn the ignition switch OFF, and then turn the ignition to ACC again.
28. Check the software version to make sure it is the same as on the USB memory stick. See MAZDA CONNECT Software Version Verification Procedure.
29. Turn the ignition switch OFF, then remove the USB memory stick from the USB port.
NOTE: Before attempting to re-pair a phone to the system, delete MAZDA from the list of Bluetooth devices on any phone that is paired with the system. If not deleted, the phone will not be able to be paired with the system because the phone will think it is already paired.
30. Disconnect the battery charger from the vehicle.
31. Insert the SD card into the slot.
32. Set the customer's radio favorites (AM/FM/XM).

CAMPAIGN LABEL:

1. Fill out a blue "Campaign Label" (9999-95-065A-06) with the Campaign No: "MSP41", your dealer code, today's date, and affix it to the vehicle's bulkhead or hood.

CAMPAIGN LABEL	
CAMPAIGN NO:	_____
DEALER CODE:	_____
DATE:	/ /

P/N 9999-95-065A-06

1326b

2. Return the vehicle to the customer or dealer inventory.

WARRANTY INFORMATION

NOTE:

- This repair will be covered under Mazda's New Vehicle Limited Warranty term.
- Additional diagnostic time cannot be claimed for this repair.

Warranty Type	A
Process Number	AD027B
Symptom Code	99
Damage Code	99
Part Number Main Cause	7777-SP-J31
Quantity	0
Operation Number / Labor Hours:	XXK1HXFX / 0.3 Hrs.